

# INSTALLATION MANUAL

For authorized service personnel only.

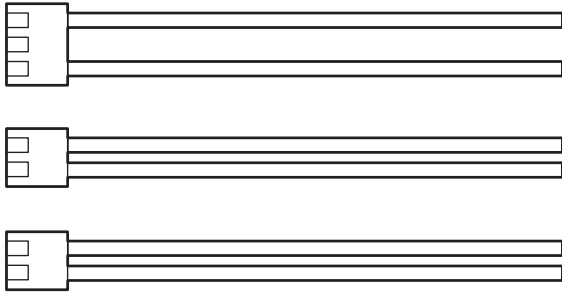

## 3. SETTING

### 3.1. External Input

#### 3.1.1. Control Input (Operation/Stop or Forced stop)

- The air conditioner can be remotely operated by means of the following on-site work. "Operation/Stop" mode or "Forced stop" mode can be selected with function setting of indoor unit.

#### Circuit diagram example

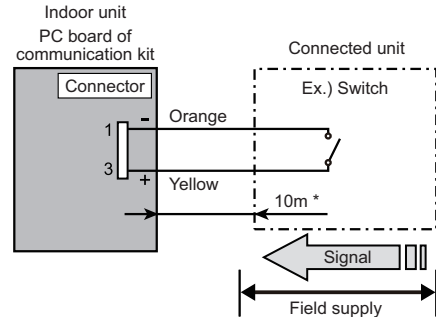

- \* Make the distance from the PC board to the connected unit within 10m. Contact capacity : 24VDC or more, 10mA or more.

#### • When function setting is "Operation/Stop" mode

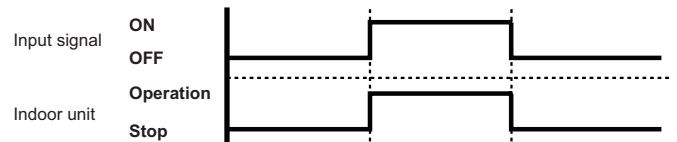

#### • When function setting is "Forced stop" mode

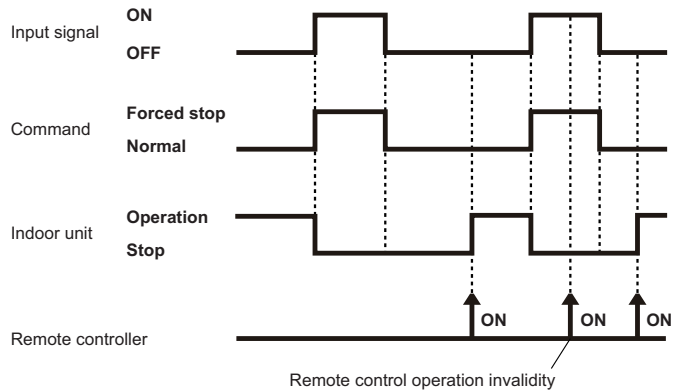

#### NOTE

- Operation mode, temperature, and airflow cannot be set by external input. Use the remote controller to set.
- If the air conditioner is activated by external input, it will operate in the settings before stop. To change the settings, use the remote controller.

## 1. SAFETY PRECAUTIONS

- WARNING** This mark indicates procedures which, if improperly performed, might lead to the death or serious injury of the user.

When installing each wire, please thoroughly read this manual.

Before installation be sure that all sources of power have been shut off. There is a danger of electric shock.

For input/output, use the voltage as described in the signal specifications. Using voltage of other specifications may result in malfunction and erroneous operation of the air conditioner.







- CAUTION** This mark indicates procedures which, if improperly performed, might possibly result in personal harm to the user, or damage to property.

Do not pull on the connectors with too much force.

## 2. ABOUT THE UNIT

### 2.1. Main Unit & Accessories

- The following installation parts are supplied. Use them as required.

Name and Shape	Q'ty	Application
Installation manual 	1	This manual
Wire (External input): Orange / Yellow 	1	For connect to External device for input.
Wire (External output): Blue / Purple 	1	For connect to External device for operation status output.
Wire (External output): Red / White 	1	For connect to External device for error status output.
Binder clamp 	1	For fixing the binder.
Binder 	1	For fixing the wires.
Screw 	1	For fixing the binder clamp.

### 3.2. External Output

#### 3.2.1. Operation Status Output

- An air conditioner operation status signal can be output.

##### Circuit diagram example

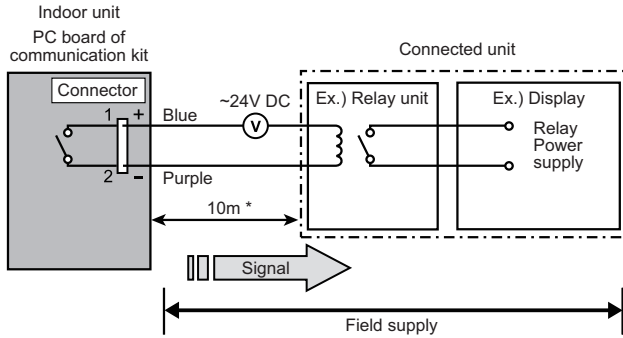

\* Make the distance from the PC board to the connected unit within 10m.  
Relay spec. : Max.24V DC, 10mA to less than 500mA.

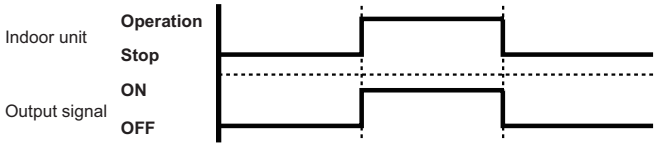

##### NOTE

- Only operation and stop signals will be output.  
Use the remote controller to check the operation mode, temperature, and airflow.

#### 3.2.2. Error Status Output

- An air conditioner condition normal/error status signal can be output.

##### Circuit diagram example

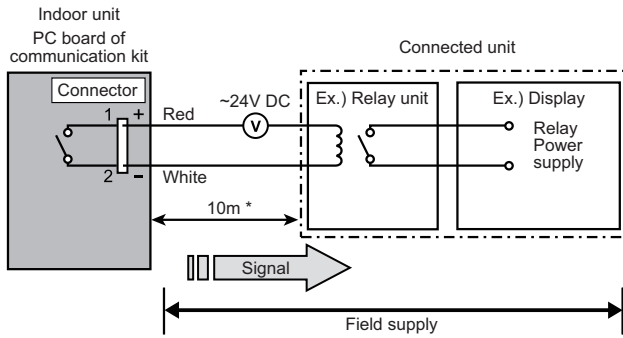

\* Make the distance from the PC board to the connected unit within 10m.  
Relay spec. : Max.24V DC, 10mA to less than 500mA

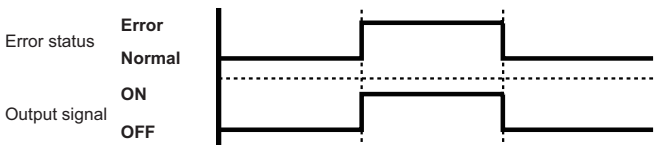

##### NOTE

- Only error signals will be output.  
Check the error information on the display area of the main unit.

### 4. CONNECTING TO INDOOR UNIT

- Connect the connector to the board of the air-conditioner.  
To connect to the air-conditioner, refer to the installation manual of the air-conditioner.
- Connect the tip of the wire to the external equipment.  
If necessary, extend it with locally procured wire.
- Ensure that the connecting part is insulated for protection.