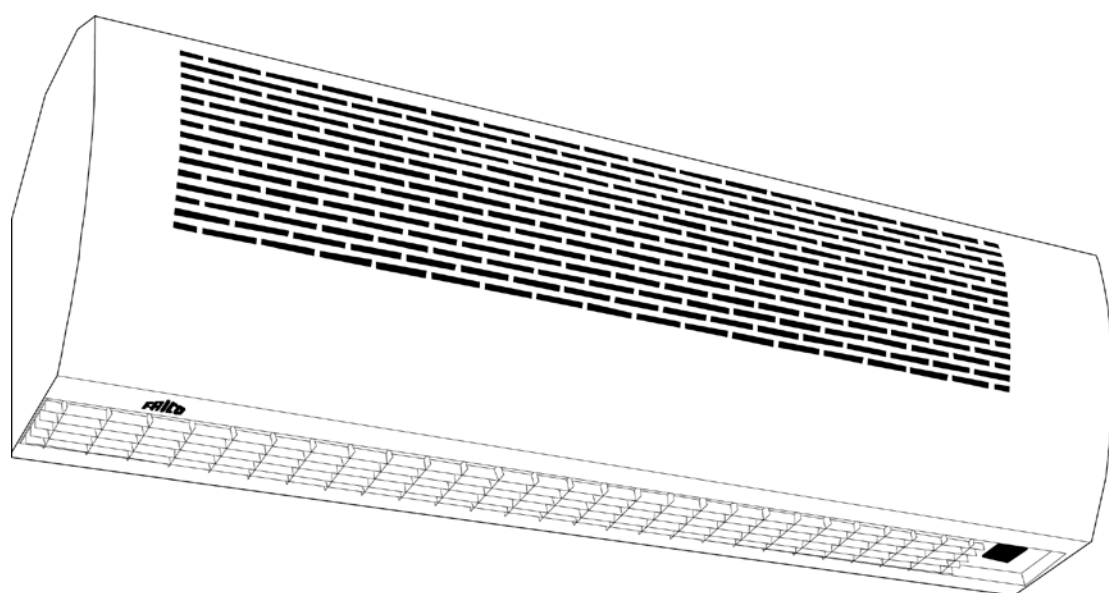

Thermozone ADA

SE ... 2

GB ... 2

NO ... 2

FR ... 2

RU ... 2

DE ... 2

PL ... 2

FI ... 2

ES ... 2

NL ... 2

Thermozone ADA

1

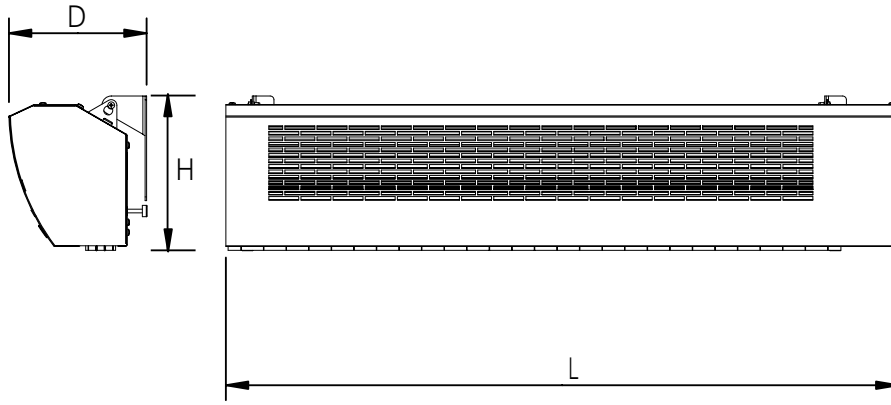

	L	H	D	
090L	900	190	175	mm
090H	900	235	215	mm
120L	1200	190	175	mm
120H	1200	235	215	mm

2

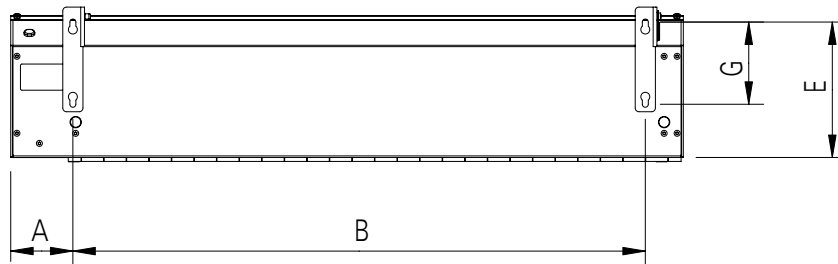

	A	B	E	G	
090L	87	800	170	90	mm
090H	95	747	216	110	mm
120L	87	1100	170	90	mm
120H	95	1047	216	135	mm

3

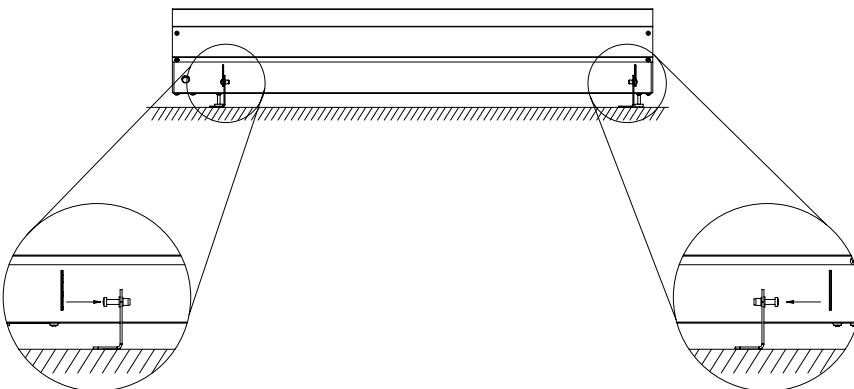

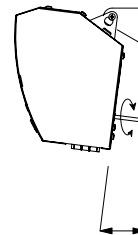

4

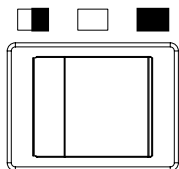

Thermozone ADA



			
090L	625	820	m ³ /h
090H	800	1150	m ³ /h
120L	900	1350	m ³ /h
120H	1100	1400	m ³ /h



090L	8.7 kg	54 dB(A)
090H	9.5 kg	54 dB(A)
120L	10.8 kg	55 dB(A)
120H	11.7 kg	51 dB(A)

- SE: En skadad nätkabel får endast bytas av en behörig installatör
- GB: A damaged mains cable must only be changed by a competent electrician.
- NO: En skadet nettleddning skal kun byttes av godkjent installatør.
- FR: Un câble d'alimentation défectueux ne doit être remplacé que par un électricien qualifié.
- RU: В случае повреждения питающего кабеля он должен быть заменен квалифицированным электриком.
- DE: Ein beschädigtes Netzkabel darf nur durch einen ausgebildeten Elektriker ausgetauscht werden.
- PL: Zniszczone przewody elektryczne mogą być wymienione tylko przez elektryka posiadającego odpowiednie uprawnienia elektryczne.
- FI: Vahingoittuneen verkkojohdon saa vaihtaa vain valtuutettu asentaja.
- ES: Un cable principal dañado sólo debe ser sustituido por un electricista cualificado.
- NL: Beschadigde bedrading mag uitsluitend door een bevoegde elektromonteur worden vervangen / gerepareerd.

230 / 220 V~
 50 / 60 Hz
 090H: 0,5 A, 120H: 0,55A (at highest)
 090L: 0,4 A, 0120L: 0,45 A (at highest)

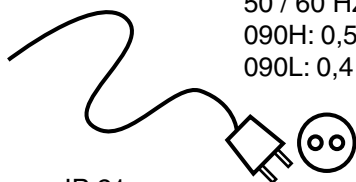

IP 21

Main office

Frico AB
Box 102
SE-433 22 Partille
Sweden

Tel: +46 31 336 86 00
Fax: +46 31 26 28 25
mailbox@frico.se
www.frico.se

**For latest updated information and information
about your local contact: www.frico.se**