

AIR CONDITIONER INDOOR UNIT Ceiling type

CAUTION

**R410A
REFRIGERANT**

This Air Conditioner contains and operates with refrigerant R410A.

THIS PRODUCT MUST ONLY BE INSTALLED OR SERVICED BY QUALIFIED PERSONNEL.

Refer to Commonwealth, State, Territory and local legislation, regulations, codes, installation & operation manuals, before the installation, maintenance and/or service of this product.

INSTALLATION MANUAL

For authorized service personnel only.

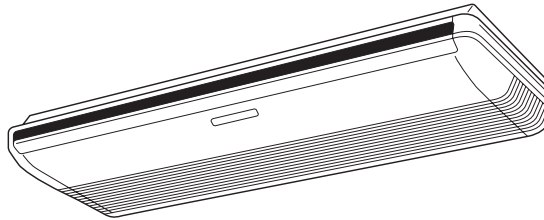

Contents

1. SAFETY PRECAUTIONS.....	2	7. REMOTE CONTROLLER SETTING.....	11
2. ABOUT THE UNIT.....	2	7.1. Load batteries (R03/LR03 × 2)	
2.1. Precautions for using R410A refrigerant		7.2. Remote control unit holder installation	
2.2. Special tools for R410A		8. FUNCTION SETTING.....	11
2.3. Accessories		8.1. Entering the function setting mode	
2.4. Optional parts		8.2. Function setting	
3. INSTALLATION WORK.....	3	9. SELECTING THE REMOTE CONTROL UNIT SIGNAL CODE.....	13
3.1. Selecting an installation location		10. TEST RUN.....	14
3.2. Installation dimension		11. CHECK LIST.....	14
3.3. Installation the unit		12. ERROR CODES.....	15
4. PIPE INSTALLATION.....	6	13. SPECIAL INSTALLATION METHODS.....	16
4.1. Selecting the pipe material		14. FRESH-AIR INTAKE.....	16
4.2. Pipe requirement		15. CUSTOMER GUIDANCE.....	16
4.3. Flare connection (pipe connection)			
4.4. Installing heat insulation			
5. INSTALLING DRAIN PIPES.....	8		
6. ELECTRICAL WIRING.....	9		
6.1. Electrical requirement			
6.2. Wiring method			

1. SAFETY PRECAUTIONS

- Be sure to read this Manual thoroughly before installation.
- The warnings and precautions indicated in this Manual contain important information pertaining to your safety. Be sure to observe them.
- Hand this Manual, together with the Operating Manual, to the customer. Request the customer to keep them on hand for future use, such as for relocating or repairing the unit.

WARNING

This mark indicates procedures which, if improperly performed, might lead to the death or serious injury of the user.

- Request your dealer or a professional installer to install the indoor unit in accordance with this Installation Manual. An improperly installed unit can cause serious accidents such as water leakage, electric shock, or fire. If the indoor unit is installed in disregard of the instructions in the Installation Manual, it will void the manufacturer's warranty.
- Do not turn ON the power until all work has been completed. Turning ON the power before the work is completed can cause serious accidents such as electric shock or fire.
- If refrigerant leaks while work is being carried out, ventilate the area. If the refrigerant comes in contact with a flame, it produces a toxic gas.
- Installation work must be performed in accordance with national wiring standards by authorized personnel only.

CAUTION

This mark indicates procedures which, if improperly performed, might possibly result in personal harm to the user, or damage to property.

2. ABOUT THE UNIT

2.1. Precautions for using R410A refrigerant

WARNING

- Do not introduce any substance other than the prescribed refrigerant into the refrigeration cycle. If air enters the refrigeration cycle, the pressure in the refrigeration cycle will become abnormally high and cause the piping to rupture.
- If there is a refrigerant leak, make sure that it does not exceed the concentration limit. If a refrigerant leak exceeds the concentration limit, it can lead to accidents such as oxygen starvation.
- Do not touch refrigerant that has leaked from the refrigerant pipe connections or other area. Touching the refrigerant directly can cause frostbite.
- If a refrigerant leak occurs during operation, immediately vacate the premises and thoroughly ventilate the area. If the refrigerant comes in contact with a flame, it produces a toxic gas.

2.2. Special tools for R410A

WARNING

- To install a unit that uses R410A refrigerant, use dedicated tools and piping materials that have been manufactured specifically for R410A use. Because the pressure of R410A refrigerant is approximately 1.6 times higher than the R22, failure to use dedicated piping material or improper installation can cause rupture or injury. Furthermore, it can cause serious accidents such as water leakage, electric shock, or fire.















Tool name	Changes
Gauge manifold	The pressure in the refrigerant system is extremely high and cannot be measured with a conventional gauge. To prevent erroneous mixing of other refrigerants, the diameter of each port has been changed. It is recommended to use a gauge manifold with a high pressure display range of -0.1 to 5.3 MPa and a low pressure display range of -0.1 to 3.8 MPa.
Charging hose	To increase pressure resistance, the hose material and base size were changed. (The charging port thread diameter for R410A is 1/2 UNF 20 threads per inch.)
Vacuum pump	A conventional vacuum pump can be used by installing a vacuum pump adapter. Be sure that the pump oil does not backflow into the system. Use one capable for vacuum suction of -100.7 kPa (5 torr, -755 mmHg).
Gas leakage detector	Special gas leakage detector for R410A refrigerant.

2.3. Accessories

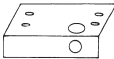

WARNING

- For installation purposes, be sure to use the parts supplied by the manufacturer or other prescribed parts. The use of non-prescribed parts can cause serious accidents such as the unit falling, water leakage, electric shock, or fire.

- The following installation parts are furnished. Use them as required.
- Keep the Installation Manual in a safe place and do not discard any other accessories until the installation work has been completed.

Name and Shape	Q'ty	Description
Drain hose insulation 	1	Adhesive type 70 × 230
VT wire 	1	For fixing the drain hose L : 280 mm
Coupler heat insulation (Large) 	2	For indoor side pipe joint (Gas pipe)
Coupler heat insulation (Small) 	1	For indoor side pipe joint (Liquid pipe)
Binder (Large) 	4	For fixing the coupler heat insulator
Binder (Small) 	4	For fixing the coupler heat insulator
Special nut A (Large flange) 	4	For installing indoor unit
Special nut B (Small flange) 	4	For installing indoor unit
Installation template 	1	For positioning the indoor unit
Auxiliary pipe assembly 	1	For connecting the piping
Remote control unit 	1	Use for air conditioner operation
Battery (Penlight) 	2	For remote control unit
Remote control unit holder 	1	Use as remote control unit holder
Screw (M3 × 12) 	2	For remote control unit holder installation

2.4. Optional parts

Exterior	Parts name	Model No.	Summary
	Wired remote controller	UTB-*UD	Unit control is performed by wired remote controller
	Round duct	UTD-RF204	For Ceiling type
	Drain pump unit	UTR-DPB241	For Ceiling type

3. INSTALLATION WORK

Especially, the installation place is very important for the split type air conditioner because it is very difficult to move from place to place after the first installation.

3.1. Selecting an installation location

Decide the mounting position together with the customer as follows.

WARNING

- Select installation locations that can properly support the weight of the indoor unit. Install the units securely so that they do not topple or fall.

CAUTION

- Do not install the indoor unit in the following areas:
 - Area with high salt content, such as at the seaside. It will deteriorate metal parts, causing the parts to fall or the unit to leak water.
 - Area filled with mineral oil or containing a large amount of splashed oil or steam, such as a kitchen. It will deteriorate plastic parts, causing the parts to fall or the unit to leak water.
 - Area that generates substances that adversely affect the equipment, such as sulfuric gas, chlorine gas, acid, or alkali. It will cause the copper pipes and brazed joints to corrode, which can cause refrigerant leakage.
 - Area that can cause combustible gas to leak, contains suspended carbon fibers or flammable dust, or volatile inflammables such as paint thinner or gasoline. If gas leaks and settles around the unit, it can cause a fire.
 - Area where animals may urinate on the unit or ammonia may be generated.

- Do not install where there is the danger of combustible gas leakage.

- Do not install the unit near a source of heat, steam, or flammable gas.

- Install the indoor unit, outdoor unit, power supply cable, transmission cable, and remote control cable at least 1 m away from a television or radio receivers. The purpose of this is to prevent TV reception interference or radio noise. (Even if they are installed more than 1 m apart, you could still receive noise under some signal conditions.)

- If children under 10 years old may approach the unit, take preventive measures so that they cannot reach the unit.

- (1) Install the indoor unit on a place having a sufficient strength so that it withstands against the weight of the indoor unit.
- (2) The inlet and outlet ports should not be obstructed; the air should be able to blow all over the room.
- (3) Leave the space required to service the air conditioner.
- (4) Install the unit where connection to the outdoor unit is easy.
- (5) Install the unit where the connection pipe can be easily installed.
- (6) Install the unit where the drain pipe can be easily installed.
- (7) Install the unit where noise and vibrations are not amplified.
- (8) Take servicing, etc., into consideration and leave the spaces. Also install the unit where the filter can be removed.
- (9) Do not install the unit where it will be exposed to direct sunlight.

3.2. Installation dimension

- The ceiling rear height as shown in the figure.

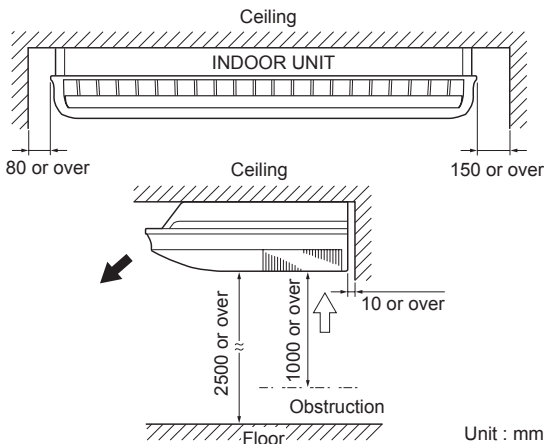

[FOR HALF CONCEALED INSTALLATION]

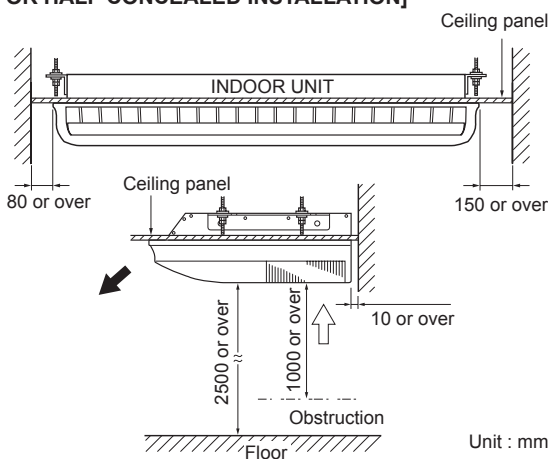

3.3. Installation the unit

⚠ WARNING

- Install the air conditioner in a location which can withstand a load of at least five times the weight of the main unit and which will not amplify sound or vibration. If the installation location is not strong enough, the indoor unit may fall and cause injuries.

3.3.1. Preparing indoor unit installation

Remove the intake grille and side cover

- (1) Remove the two Air filters.
- (2) Remove the two Intake grilles.
 - For ④ Left rear drain and ⑤ Left drain: Remove air filters and intake grilles at three places.
- (3) Remove the Side cover A (Right side) and Side cover B (Right and Left side).
 - For ⑤ Left drain: Remove both the Side cover A (Right and Left side).
- (4) This air conditioner can be set up to intake fresh air. For information about how to install for fresh-air intake, refer to "14. FRESH-AIR INTAKE".

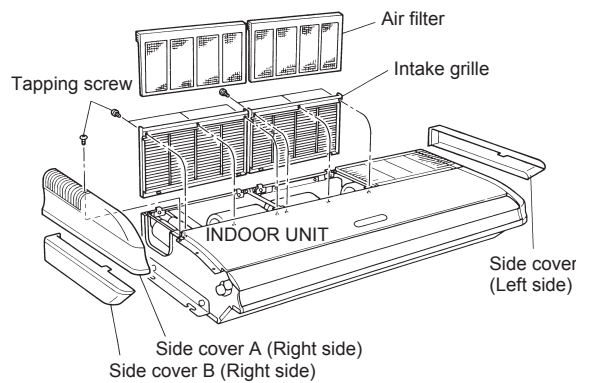

3.3.2. Indoor unit installation

- You can use the accessory template to help you install the indoor unit.
- The template helps you determine the appropriate locations for suspension bolts and pipe opening (drain pipe and connection cable).

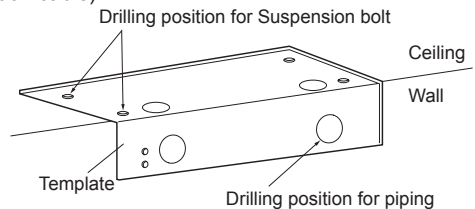

3.3.3. Location of ceiling suspension bolts

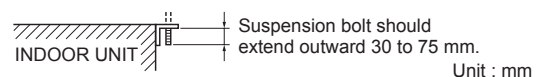
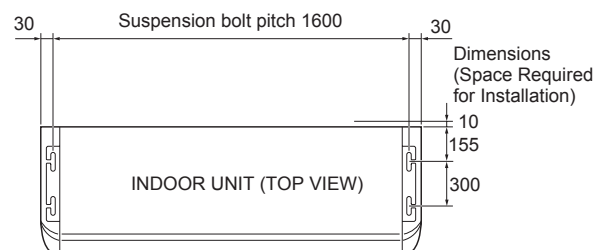

[For Half-Concealed Installation]

- Suspension-bolt pitch should be as shown in the figure.

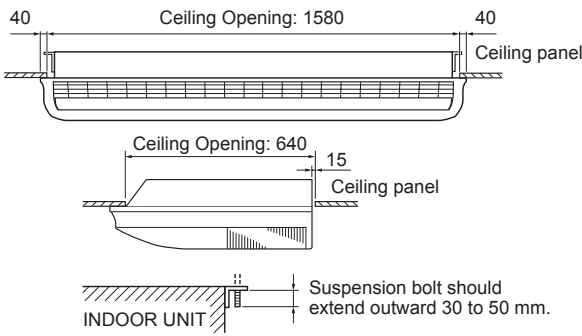

Unit : mm

3.3.4. Select piping direction

- Select connection piping and drain piping directions.

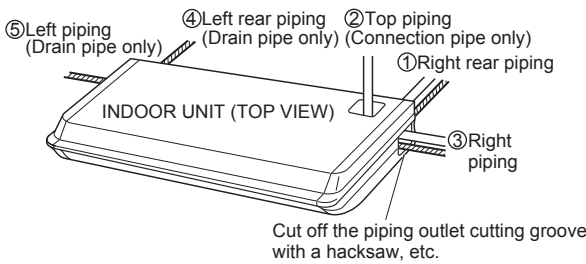

[FOR ④ Left rear piping, ⑤ Left piping]

- Transfer the Drain cap and Drain cap seal.

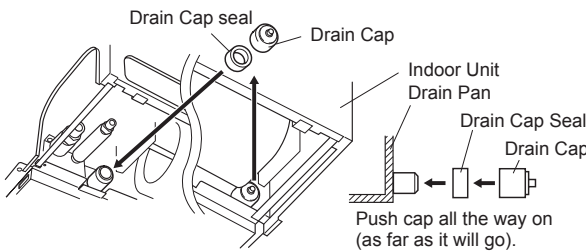

3.3.5. Drilling the holes and attaching the suspension bolts

- (1) Drill $\varnothing 25$ mm holes at the suspension-bolt locations.
- (2) Install the bolts, then temporarily attach Special nuts A and B and a normal M10 nut to each bolt. (The two special nuts are provided with the unit. The M10 nut must be obtained locally.) Refer to the figure.

Bolt Strength [N (kgf)]	980 to 1470 (100 to 150)
--------------------------------	--------------------------

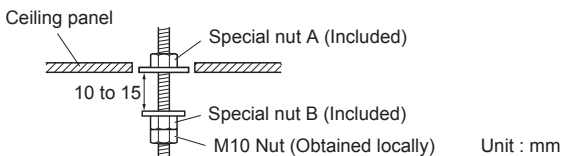

Unit : mm

3.3.6. Installing the indoor unit

- (1) Lift unit so that suspension bolts pass through the suspension fittings at the sides (four places), and slide the unit back.

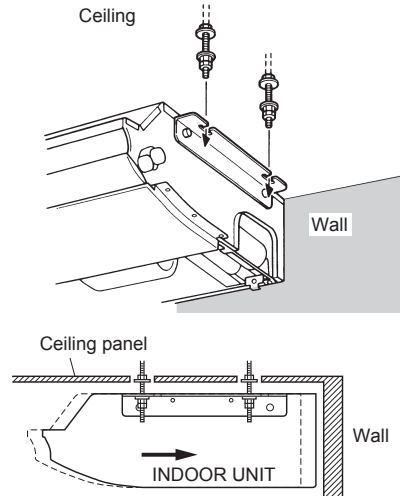

- (2) Fasten the indoor unit into place by tightening-up the special "B" bolts and the M10 nuts. Make sure that unit is secure and will not shift back and forth.

[For Half-Concealed Installation]

When installing the indoor unit in a semi-concealed orientation, make sure to reinforce the insulation of the unit on all sides. Drops of water may fall from the unit if it is not thoroughly insulated.

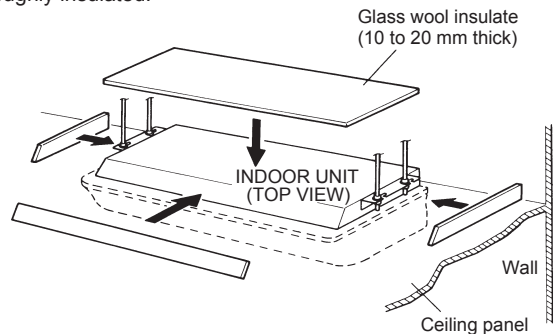

⚠ CAUTION
<ul style="list-style-type: none"> • In order to check the drainage, be sure to use a level during installation of the indoor unit. If the installation site of the indoor unit is not level, water leakage may occur.

4. PIPE INSTALLATION

CAUTION

- Be more careful that foreign matter (oil, water, etc.) does not enter the piping than with refrigerant R410A models. Also, when storing the piping, securely seal the openings by pinching, taping, etc.
- While welding the pipes, be sure to blow dry nitrogen gas through them.

4.1. Selecting the pipe material

CAUTION

- Do not use existing pipes.
- Use pipes that have clean external and internal sides without any contamination which may cause trouble during use, such as sulfur, oxide, dust, cutting waste, oil, or water.
- It is necessary to use seamless copper pipes.
Material : Phosphor deoxidized seamless copper pipes
It is desirable that the amount of residual oil is less than 40 mg/10 m.
- Do not use copper pipes that have a collapsed, deformed, or discolored portion (especially on the interior surface). Otherwise, the expansion valve or capillary tube may become blocked with contaminants.
- Improper pipe selection will degrade performance. As an air conditioner using R410A incurs pressure higher than when using conventional refrigerant, it is necessary to choose adequate materials.

- Thicknesses of copper pipes used with R410A are as shown in the table.
- Never use copper pipes thinner than those indicated in the table even if they are available on the market.

Thicknesses of Annealed Copper Pipes (R410A)

Pipe outside diameter [mm (in.)]	Thickness [mm]
6.35 (1/4)	0.80
9.52 (3/8)	0.80
12.70 (1/2)	0.80
15.88 (5/8)	1.00
19.05 (3/4)	1.20

4.2. Pipe requirement

CAUTION

- Refer to the Installation Manual of the outdoor unit for description of the length of connecting pipe or for difference of its elevation.

Diameter [mm (in.)]	Liquid	9.52 (3/8)
	Gas	15.88 (5/8)

- Use pipe with water-resistant heat insulation.

CAUTION

- Install heat insulation around both the gas and liquid pipes. Failure to do so may cause water leaks. Use heat insulation with heat resistance above 120 °C. (Reverse cycle model only)
In addition, if the humidity level at the installation location of the refrigerant piping is expected to exceed 70 %, install heat insulation around the refrigerant piping. If the expected humidity level is 70-80 %, use heat insulation that is 15 mm or thicker and if the expected humidity exceeds 80 %, use heat insulation that is 20 mm or thicker. If heat insulation is used that is not as thick as specified, condensation may form on the surface of the insulation.
In addition, use heat insulation with heat conductivity of 0.045 W/(m·K) or less (at 20 °C).

4.3. Flare connection (pipe connection)

4.3.1. Flaring

- Use special pipe cutter and flare tool exclusive for R410A.
- (1) Cut the connection pipe to the necessary length with a pipe cutter.
 - (2) Hold the pipe downward so that cuttings will not enter the pipe and remove any burrs.
 - (3) Insert the flare nut (always use the flare nut attached to the indoor and outdoor units respectively) onto the pipe and perform the flare processing with a flare tool. Use the special R410A flare tool, or the conventional flare tool. Leakage of refrigerant may result if other flare nuts are used.
 - (4) Protect the pipes by pinching them or with tape to prevent dust, dirt, or water from entering the pipes.

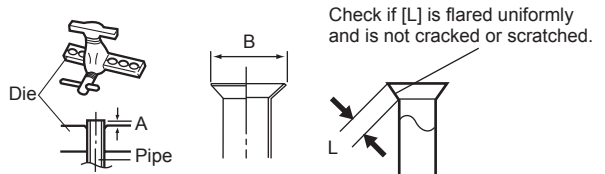

Pipe outside diameter [mm (in.)]	Dimension A [mm]	Dimension B ⁰ _{-0.4} [mm]
	Flare tool for R410A, clutch type	
6.35 (1/4)	0 to 0.5	9.1
9.52 (3/8)		13.2
12.70 (1/2)		16.6
15.88 (5/8)		19.7
19.05 (3/4)		24.0

When using conventional flare tools to flare R410A pipes, the dimension A should be approximately 0.5 mm more than indicated in the table (for flaring with R410A flare tools) to achieve the specified flaring. Use a thickness gauge to measure the dimension A.

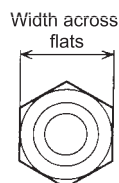

Pipe outside diameter [mm (in.)]	Width across flats of Flare nut [mm]
6.35 (1/4)	17
9.52 (3/8)	22
12.70 (1/2)	26
15.88 (5/8)	29
19.05 (3/4)	36

4.3.2 Bending pipes

- If pipes are shaped by hand, be careful not to collapse them.
- Do not bend the pipes in an angle more than 90°.
- When pipes are repeatedly bend or stretched, the material will harden, making it difficult to bend or stretch them any more. Do not bend or stretch the pipes more than three times.

⚠ CAUTION

- To prevent breaking of the pipe, avoid sharp bends.
- If the pipe is bent repeatedly at the same place, it will break.

4.3.3. Pipe connection

⚠ CAUTION

- Be sure to apply the pipe against the port on the indoor unit and the outdoor unit correctly. If the centering is improper, the flare nut cannot be tightened smoothly. If the flare nut is forced to turn, the threads will be damaged.
- Do not remove the flare nut from the indoor unit pipe until immediately before connecting the connection pipe.
- Do not use mineral oil on flared part. Prevent mineral oil from getting into the system as this would reduce the lifetime of the units.

(1) Remove the filter guide.

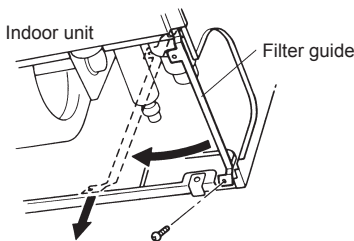

(2) Detach the caps and plugs from the pipes.

(3) Center the pipe against the port on the indoor unit, and then turn the flare nut by hand.

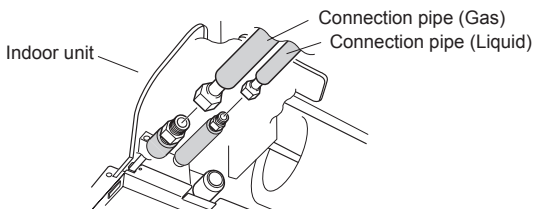

- For ② Top piping and ③ Right piping connections, use the Auxiliary pipe (Gas pipe) provided.

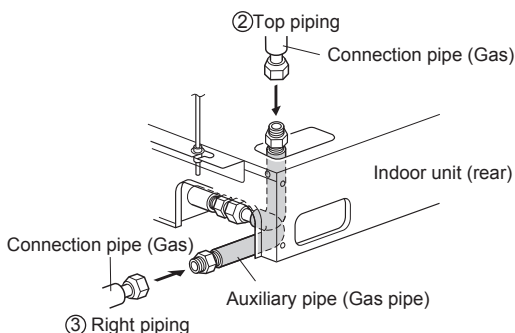

(4) When the flare nut is tightened properly by your hand, hold the body side coupling with a separate spanner, then tighten with a torque wrench. (See the table below for the flare nut tightening torques.)

⚠ CAUTION

- Hold the torque wrench at its grip, keeping it in the right angle with the pipe, in order to tighten the flare nut correctly.
- Tighten the flare nuts with a torque wrench using the specified tightening method. Otherwise, the flare nuts could break after a prolonged period, causing refrigerant to leak and generate a hazardous gas if the refrigerant comes into contact with a flame.

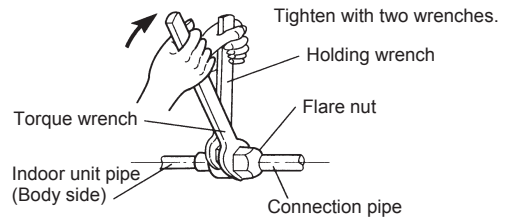

Flare nut [mm (in.)]	Tightening torque [N·m (kgf·cm)]
6.35 (1/4) dia.	16 to 18 (160 to 180)
9.52 (3/8) dia.	32 to 42 (320 to 420)
12.70 (1/2) dia.	49 to 61 (490 to 610)
15.88 (5/8) dia.	63 to 75 (630 to 750)
19.05 (3/4) dia.	90 to 110 (900 to 1,100)

4.4. Installing heat insulation

CAUTION

- After checking for gas leaks (refer to the Installation Manual of the outdoor unit), perform this section.
- Install heat insulation around both the large (gas) and small (liquid) pipes. Failure to do so may cause water leaks.

After checking for gas leaks, insulate by wrapping insulation around the two parts (Gas and Liquid) of the indoor unit coupling, using the coupler heat insulation. After installing the coupler heat insulation, wrap both ends with vinyl tape so that there is no gap. Secure both ends of the heat insulation material using Binder. And finally fix connection pipe (Liquid) to connection pipe (Gas) by rolling vinyl tape over coupler heat insulation (Gas) and coupler heat insulation (Liquid).

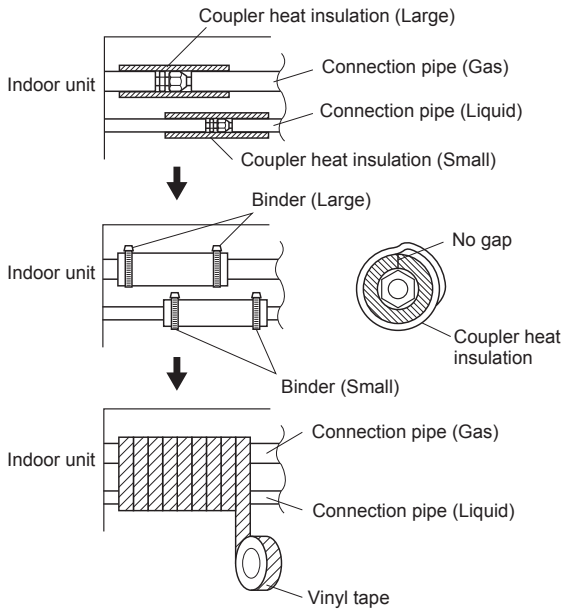

- When using an auxiliary pipe, make sure that the Binder used is insulated in the same way

CAUTION

- There should be no gaps between the insulation and the unit.

5. INSTALLING DRAIN PIPES

CAUTION

- Install the drain pipe in accordance with the instructions in this Installation Manual and keep the area warm enough to prevent condensation. Problems with the piping may lead to water leaks.

- Install the drain pipe with downward gradient (1/50 to 1/100) and so there are no rises or traps in the pipe.
- Use general hard polyvinyl chloride pipe (VP25) [outside diameter 38 mm].
- During installation of the drain pipe, be careful to avoid applying pressure to the drain port of the indoor unit.
- When the pipe is long, install supporters.
- Do not perform air bleeding.

- Always heat insulate (8 mm or over thick) the indoor side of the drain pipe.

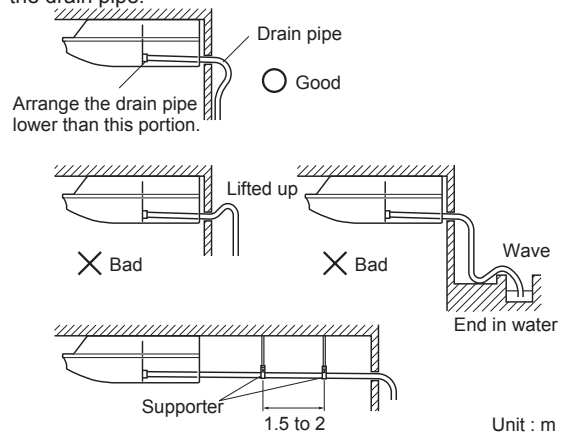

- (1) Install insulation for the drain pipe.

Cut the included insulation material to an appropriate size and adhere it to the pipe.

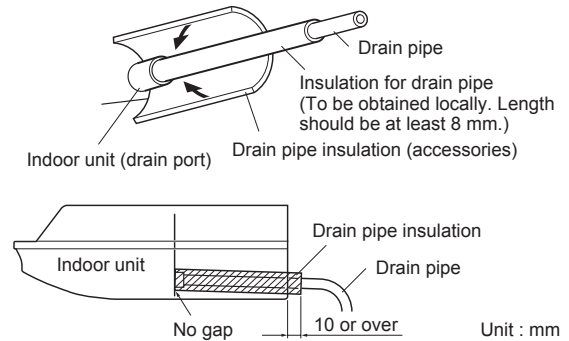

- (2) If "① Right rear piping": fasten the drain pipe with VT wire so that the pipe slopes correctly within the indoor unit.

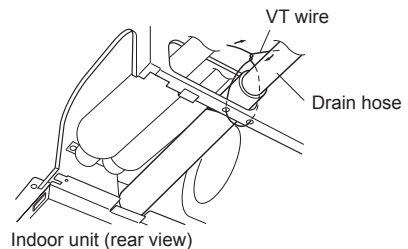

- (3) If the drain hose will not be connected to the right rear piping, cut the hole cover at the points indicated in Fig. (a), and attach it to the piping hole as shown in Fig. (b).

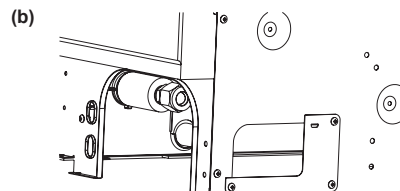
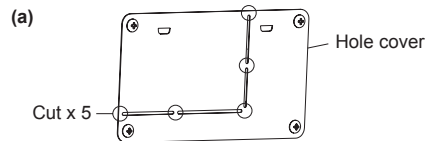

6. ELECTRICAL WIRING

⚠ WARNING

- Electrical work must be performed in accordance with this Manual by a person certified under the national or regional regulations. Be sure to use a dedicated circuit for the unit.
An insufficient power supply circuit or improperly performed electrical work can cause serious accidents such as electric shock or fire.
- Before starting work, check that power is not being supplied to the indoor unit and outdoor unit.
- Use the included connection cables and power cables or ones specified by the manufacturer. Improper connections, insufficient insulation, or exceeding the allowable current can cause electric shock or fire.
- For wiring, use the prescribed type of wires, connect them securely, making sure that there are no external forces of the wires applied to the terminal connections. Improperly connected or secured wires can cause serious accidents such as overheating the terminals, electric shock, or fire.
- Do not modify the power cables, use extension cables, or use any branches in the wiring. Improper connections, insufficient insulation, or exceeding the allowable current can cause electric shock or fire.
- Match the terminal block numbers and connection cable colors with those of the outdoor unit. Erroneous wiring may cause burning of the electric parts.
- Securely connect the connection cables to the terminal blocks. In addition, secure the cables with wiring holders. Improper connections, either in the wiring or at the ends of the wiring, can cause a malfunction, electric shock, or fire.
- Always fasten the outside covering of the connection cable with the cable clamp. (If the insulator is chafed, electric leakage may occur.)
- Securely install the electrical box cover on the unit. An improperly installed electrical box cover can cause serious accidents such as electric shock or fire through exposure to dust or water.
- Install sleeves into any holes made in the walls for wiring. Otherwise, a short circuit could result.
- Install a ground leakage breaker. In addition, install the ground leakage breaker so that the entire AC main power supply is cut off at the same time. Otherwise, electric shock or fire could result.
- Install a ground leakage breaker.
If a ground leakage breaker is not installed, it may cause electric shock or fire.
- Always connect the ground wire.
Improper grounding work can cause electric shocks.
- Install the remote controller wires so as not to be direct touched with your hand.

6.1. Electrical requirement

Connection cable (mm ²)	
MAX.	MIN.
2.5	1.5

- Use conformed cable with Type 245 IEC57.
- Perform all electrical work according to the standard.
- Install circuit breakers, which have the terminal spacing of more than 3 mm, in a place of near the indoor unit and outdoor unit.

⚠ CAUTION

- Be sure to execute the electrical work according to the Laws of each country and the Installation Instructions. In addition, be sure to set as exclusive line and use the rated voltage and circuit breaker.

6.2. Wiring method

6.2.1. Connection diagrams

- Connection cable (to outdoor unit)

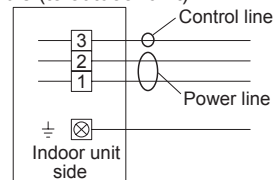

- Wired remote controller cable

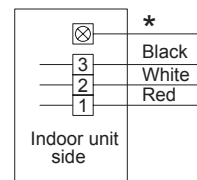

- * Ground the remote controller if it has a ground wire.

6.2.2. Connection cable preparation

Keep the earth wire longer than the other wires.

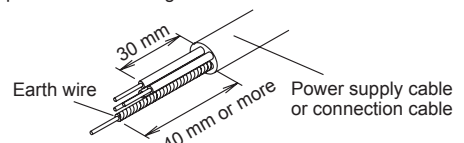

- Use a 4-core wire cable.

How to connect wiring to the terminals. (For strand wiring)

- (1) Use crimp-type terminals with insulating sleeves as shown in the figure below to connect to the terminal block.
- (2) Securely crimp the crimp-type terminals to the wires using an appropriate tool so that the wires do not come loose.

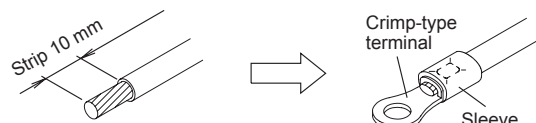

- (3) Use the specified wires, connect them securely, and fasten them so that there is no stress placed on the terminals.
- (4) Use an appropriate screwdriver to tighten the terminal screws. Do not use a screwdriver that is too small, otherwise, the screw heads may be damaged and prevent the screws from being properly tightened.
- (5) Do not tighten the terminal screws too much, otherwise, the screws may break.
- (6) See the table below for the terminal screw tightening torques.

⚠ WARNING

- Use crimp-type terminals and tighten the terminal screws to the specified torques, otherwise, abnormal overheating may be produced and possibly cause serious damage inside the unit.

Tightening torque [N·m (kgf·cm)]

M4 screw	1.2 to 1.8 (12 to 18)
M5 screw	2.0 to 3.0 (20 to 30)

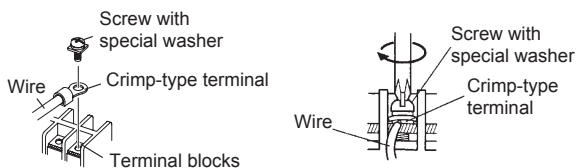

6.2.3. Wiring procedure

⚠ CAUTION

- Use care not to mistake the power supply cable and connection wires when installing.

- (1) Remove the two tapping screws and pull the Control box downward.

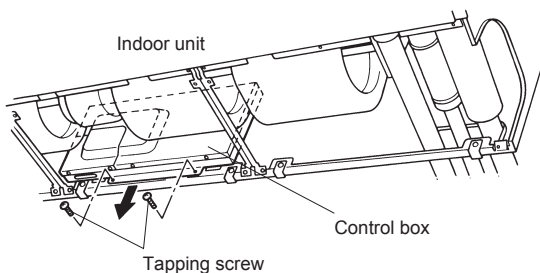

- (2) Remove the Cover A and install the connection cable.
- (3) Please fix the connection cable with cable clamp. And then install the wire cover with screws.

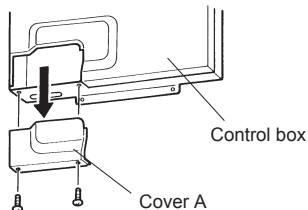

- (4) After wiring is complete, clamp the connection cable with the cable clamp.

- (5) Attach the connection cable and cable clips. Make sure that they are positioned so that they will not interfere with opening and closing of the intake grille or with removal and installation of the air filters.

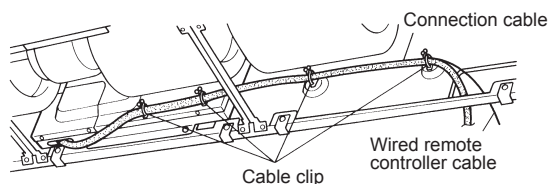
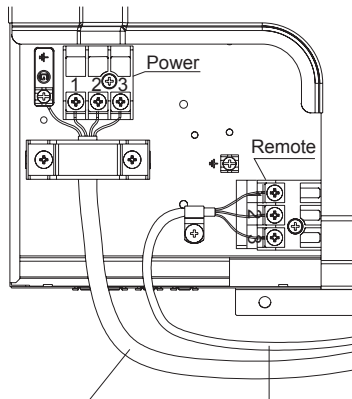

7. REMOTE CONTROLLER SETTING

7.1. Load batteries (R03/LR03 × 2)

- (1) Press and slide the battery compartment lid on the reverse side to open it. Slide in the direction of the arrow while pressing the  mark.
- (2) Insert batteries.
Be sure to align the battery polarities (+ -) correctly.
- (3) Close the battery compartment lid.

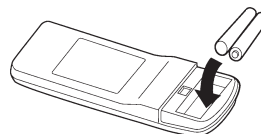

⚠ CAUTION

- Take care to prevent infants from accidentally swallowing batteries.
- When not using the Remote Control Unit for an extended period, remove the batteries to avoid possible leakage and damage to the unit.
- If leaking battery fluid comes in contact with your skin, eyes, or mouth, immediately wash with copious amounts of water, and consult your physician.
- Dead batteries should be removed immediately and disposed of properly, either in a battery collection receptacle or to the appropriate authority.
- Do not attempt to recharge dry batteries.

NOTE:

- Never mix new and used batteries, or batteries of different types.
- Batteries should last about one year under normal use. If the Remote Control Unit's operating range becomes appreciably reduced, replace the batteries and press the RESET button with the tip of a ballpoint pen or other small object.

7.2. Remote control unit holder installation**CAUTION**

- Check that the indoor unit correctly receives the signal from the remote control unit, then install the remote control unit holder.
- Select the remote control unit holder selection site by paying careful attention to the following: Avoid places in direct sunlight. Select a place that will not be affected by the heat from a stove, etc.

- Install the remote control unit with a distance of 7 m between the remote control unit and the photocell as the criteria. However, when installing the remote control unit, check that it operates positively.
- Install the remote control unit holder to a wall, pillar, etc., with the tapping screw.

(1) Mount the holder.

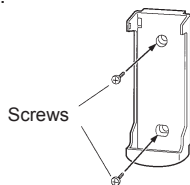

(2) Set the remote control unit.

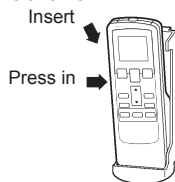

(3) To remove the remote control unit (when use at hand).

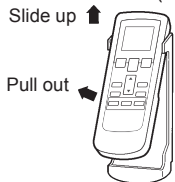
**8. FUNCTION SETTING****CAUTION**

- Confirm whether the wiring work for outdoor unit has been finished.
- Confirm whether the cap for electric control box on the outdoor unit is close.

- This procedure changes to the function settings used to control the indoor unit according to the installation conditions. Incorrect settings can cause the indoor unit malfunction.

8.1. Entering the function setting mode

- While pressing the FAN button and SET TEMP. (▲) simultaneously, press the RESET button to enter the function setting mode.

STEP 1**Selecting the Remote Control Unit Signal Code**

Use the following steps to select the signal code of the remote control unit.

(Note that the air conditioner cannot receive a signal code if the air conditioner has not been set for the signal code.) The signal codes that are set through this process are applicable only to the signals in the FUNCTION SETTING. For details on how to set the signal codes through the normal process, refer to SELECTING THE REMOTE CONTROL UNIT SIGNAL CODE.

- (1) Press the SET TEMP. (▲) (▼) button to change the signal code between **A-b-c-d**. Match the code on the display to the air conditioner signal code (initially set to **A**). (If the signal code does not need to be selected, press the MODE button and proceed to STEP 2.)
- (2) Press the TIMER MODE button and check that the indoor unit can receive signals at the displayed signal code.
- (3) Press the MODE button to accept the signal code, and proceed to STEP 2.

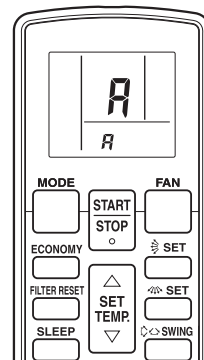

The air conditioner signal code is set to A prior to shipment. Contact your retailer to change the signal code.

The remote control unit resets to signal code A when the batteries in the remote control unit are replaced. If you use a signal code other than signal code A, reset the signal code after replacing the batteries.

If you do not know the air conditioner signal code setting, try each of the signal codes (**A-b-c-d**) until you find the code which operates the air conditioner.

8.2. Function setting

STEP 2

Selecting the Function Number and Setting Value

- Press the SET TEMP. (▲) (▼) buttons to select the function number. (Press the MODE button to switch between the left and right digits.)
- Press the FAN button to proceed to setting the value. (Press the FAN button again to return to the function number selection.)
- Press the SET TEMP. (▲) (▼) buttons to select the setting value. (Press the MODE button to switch between the left and right digits.)
- Press the TIMER MODE button, and START/STOP button, in the order listed to confirm the settings.
- Press the RESET button to cancel the function setting mode.
- After completing the FUNCTION SETTING, be sure to turn off the power and turn it on again.

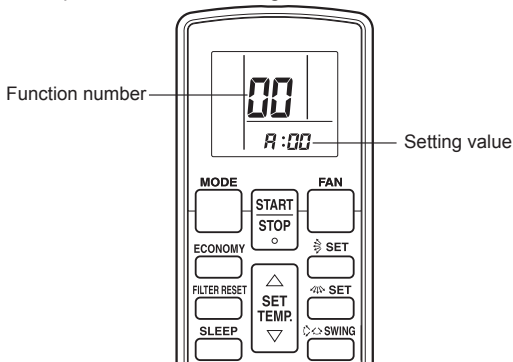

CAUTION

- After turning off the power, wait 10 seconds or more before turning on it again. The FUNCTION SETTING doesn't become effective if it doesn't do so.

Setting the Ceiling Height

- Select the setting values in the table below according to the height of the ceiling. (The unit is factory-set to "00".)

Setting Description [m]	Function Number	Setting Value
Standard (2.5 to 3.0)	20	00
High ceiling (3.0 to or more)		01

Setting the Filter Sign

- The indoor unit has a sign to inform the user that it is time to clean the filter.
- Select the time setting for the filter sign display interval in the table below according to the amount of dust or debris in the room. (The unit is factory-set to "00".)
- If you do not wish the filter sign to be displayed, select the setting value for "No indication".

Setting Description [hours]	Function Number	Setting Value
Standard (2,500)	11	00
Long interval (4,400)		01
Short interval (1,250)		02
No indication		03

Setting the Cooler Room Temperature Correction

- Depending on the installed environment, the room temperature sensor may require a correction. The settings may be selected as shown in the table below. (The unit is factory-set to "00".)

Setting Description	Function Number	Setting Value
Standard	30	00
Lower control		01

Setting the Heater Room Temperature Correction

- Depending on the installed environment, the room temperature sensor may require a correction. The settings may be changed as shown in the table below. (The unit is factory-set to "00".)

Setting Description	Function Number	Setting Value
Standard	31	00
Lower control		01
Slightly warmer control		02
Warmer control		03

Setting Other Functions

- The following settings are also possible, depending on the operating conditions. (The unit is factory-set to "00".)

Auto Restart

Setting Description	Function Number	Setting Value
Yes	40	00
No		01

Indoor Room Temperature Sensor Switching Function (Wired remote controller only)

Setting Description	Function Number	Setting Value
No	42	00
Yes		01

- If setting value is "00", room temperature is controlled by the indoor unit temperature sensor.
- If setting value is "01", room temperature is controlled by either indoor unit temperature sensor or remote control unit sensor.

Setting record

- Record any changes to the settings in the following table.

Setting	Setting Value
Ceiling height	
Filter sign	
Cooler room temperature correction	
Heater room temperature correction	
Auto restart	
Indoor room temperature sensor switching function	

After completing the FUNCTION SETTING, be sure to turn off the power and turn it on again.

9. SELECTING THE REMOTE CONTROL UNIT SIGNAL CODE

When two or more air conditioners are installed in a room and the remote control unit is operating an air conditioner other than the one you wish to set, change the signal code of the remote control unit to operate only the air conditioner you wish to set (four selections possible).

When two or more air conditioners are installed in a room, please contact your retailer to set the individual air conditioner signal codes.

- Confirm the setting of the remote control unit signal code and the printed circuit board setting.
If these are not confirmed, the remote control unit cannot be used to operate for the air conditioner.

Selecting the Remote Control Unit Signal Code

Use the following steps to select the signal code of the remote control unit.

(Note that the air conditioner cannot receive a signal code if the air conditioner has not been set for the signal code.)

- (1) Press the START/STOP button until only the clock is displayed on the remote control unit display.
- (2) Press the MODE button for at least five seconds to display the current signal code (initially set to **A**).
- (3) Press the SET TEMP. (▲) (▼) button to change the signal code between **A-b-c-d**.
Match the code on the display to the air conditioner signal code.
- (4) Press the MODE button again to return to the clock display. The signal code will be changed.

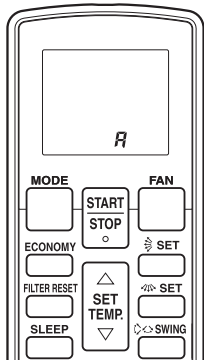

If no buttons are pressed within 30 seconds after the signal code is displayed, the system returns to the original clock display. In this case, start again from step 1.

The air conditioner signal code is set to A prior to shipment. Contact your retailer to change the signal code.

The remote control unit resets to signal code A when the batteries in the remote control unit are replaced. If you use a signal code other than signal code A, reset the signal code after replacing the batteries.

If you do not know the air conditioner signal code setting, try each of the signal codes (**A-b-c-d**) until you find the code which operates the air conditioner.

Indoor unit setting

Jumper wire		Remote control unit signal code
JM1	JM2	
Connect	Connect	A (Primary setting)
Disconnect	Connect	b
Connect	Disconnect	c
Disconnect	Disconnect	d

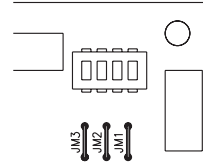
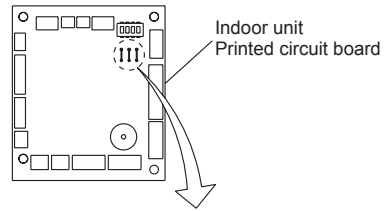

10. TEST RUN

CHECK ITEMS

- (1) Is operation of each button on the remote control unit normal?
 - (2) Does each lamp light normally?
 - (3) Do not air flow direction louvers operate normally?
 - (4) Is the drain normal?
 - (5) Is there any abnormal noise and vibration during operation?
- Do not operate the air conditioner in the running state for a long time.
 - Test running

When the air conditioner is run by pressing the remote control unit test run button, the OPERATION and TIMER Lamps flash slowly at the same time.

[Operation method]

- For the operation method, refer to the operating manual.
- The outdoor unit may not operate depending on the room temperature.
In this case, press the test run button on the remote control unit while the air conditioner is running. (Point the transmitter section of the remote control unit toward the air conditioner and press the test run button with the tip of a ball-point pen, etc.)

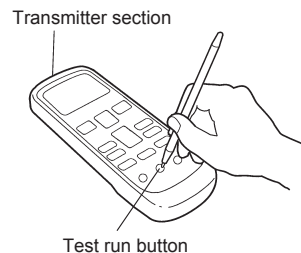

- To end test operation, press the remote control unit START/STOP button.
(When the air conditioner is run by pressing the test run button, the OPERATION Lamp and TIMER Lamp will simultaneously flash slowly.)

[Using the wired remote control] (Option)

- For the operation method, refer to the operating manual.
- Stop the air conditioner operation.
 - Press the master control button and the fan control button simultaneously for 2 seconds or more to start the test run.

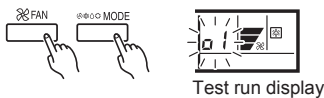

- Press the start/stop button to stop the test run.

11. CHECK LIST

Pay special attention to the check items below when installing the indoor unit(s). After installation is complete, be sure to check the following check items again.

CHECK ITEMS	If not performed correctly	CHECK BOX
Has the indoor unit been installed correctly?	Vibration, noise, indoor unit may drop	
Has there been a check for gas leaks (refrigerant pipes)?	No cooling, No heating	
Has heat insulation work been completed?	Water leakage	
Does water drain easily from the indoor units?	Water leakage	
Are the wires and pipes all connected completely?	No operation, heat or burn damage	
Is the connection cable the specified thickness?	No operation, heat or burn damage	
Are the inlets and outlets free of any obstacles?	No cooling, No heating	
After installation is completed, has the proper operation and handling been explained to the user?		

12. ERROR CODES

If you use a wired type remote control, error codes will appear on the remote control display. If you use a wireless remote control, the lamp on the photo detector unit will output error codes by way of blinking patterns. See the lamp blinking patterns and error codes in the table below.

Troubleshooting

[Troubleshooting with the indoor display]

Troubleshooting at the display is possible either on the wired or wireless remote control.

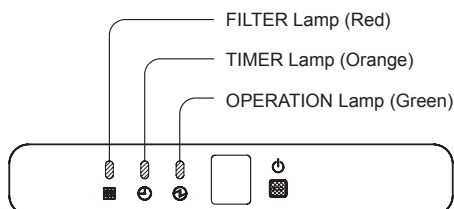

The OPERATION, TIMER and FILTER Lamp operate as follows table according to the error contents.

OPERATION Lamp	TIMER Lamp	FILTER Lamp	Error contents
×	(2 times)○	×	Indoor signal error
×	(3 times)○	×	
×	(4 times)○	×	
×	(5 times)○	×	
×	(8 times)○	×	Wired remote controller abnormal
(2 times)○	(2 times)○	×	Indoor room temperature sensor error
(2 times)○	(3 times)○	×	Indoor heat exchanger temperature sensor (middle) error
(2 times)○	(4 times)○	×	Indoor heat exchanger temperature sensor (inlet) error
(2 times)○	(6 times)○	×	Float switch operated
(3 times)○	(2 times)○	×	Outdoor discharge pipe temperature sensor error
(3 times)○	(3 times)○	×	Outdoor heat exchanger temperature sensor (outlet) error
(3 times)○	(4 times)○	×	Outdoor temperature sensor error
(3 times)○	(7 times)○	×	Heat sink thermistor (Inverter) error
(3 times)○	(8 times)○	×	Compressor temperature sensor error
(3 times)○	×	(2 times)○	2-way valve temperature sensor error
(3 times)○	×	(3 times)○	3-way valve temperature sensor error
(3 times)○	×	(4 times)○	Outdoor heat exchanger temperature sensor (middle) error
(3 times)○	×	(5 times)○	Heat sink thermistor (P.F.C) error
(4 times)○	(2 times)○	×	Indoor manual auto switch abnormal
(4 times)○	(4 times)○	×	Power supply frequency detection error
(5 times)○	(2 times)○	×	IPM protection
(5 times)○	(3 times)○	×	CT error
(5 times)○	(5 times)○	×	Compressor location error
(5 times)○	(6 times)○	×	Outdoor fan error
(5 times)○	(7 times)○	×	Connected indoor unit abnormal
(5 times)○	(8 times)○	×	Outdoor unit computer communication error
(5 times)○	×	(2 times)○	Inverter error
(6 times)○	(2 or 3 times)○	×	Indoor fan abnormal
(7 times)○	(2 times)○	×	Discharge temperature error
(7 times)○	(3 times)○	×	Excessive high pressure protection on cooling
(7 times)○	(4 times)○	×	4-way valve abnormal
(7 times)○	(5 times)○	×	Pressure switch abnormal, Pressure sensor abnormal
(7 times)○	(6 times)○	×	Compressor temperature error
(7 times)○	(7 times)○	×	Low pressure error
(8 times)○	(2 or 3 times)○	×	Active filter abnormal
(8 times)○	(4 times)○	×	P.F.C circuit error
(8 times)○	(6 times)○	×	P.F.C. printed circuit board error
(9 times)○	(2 times)○	×	Refrigerant circuit address set-up error
(9 times)○	(3 times)○	×	Master unit, Slave unit set-up error
(9 times)○	(4 times)○	×	Connected the indoor number set-up error

○:0.5s ON/0.5s OFF (Flash) ×:OFF

[Troubleshooting at the remote control LCD]

This is possible only on the wired remote control. (Option)

Self-diagnosis

This is possible only on the wired remote control. (Option)
If an error occurs, the following display will be shown.
("EE" will appear in the set room temperature display.)

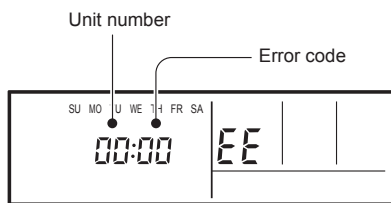

Ex. Self-diagnosis

Error code	Error contents
01 13 26 27	Indoor signal error
00	Wired remote controller abnormal
02	Indoor room temperature sensor error
04	Indoor heat exchanger temperature sensor (middle) error
28	Indoor heat exchanger temperature sensor (inlet) error
09	Float switch operated
0c	Outdoor discharge pipe temperature sensor error
06	Outdoor heat exchanger temperature sensor (outlet) error
0A	Outdoor temperature sensor error
0E	Heat sink thermistor (Inverter) error
15	Compressor temperature sensor error
1d	2-way valve temperature sensor error
1E	3-way valve temperature sensor error
29	Outdoor heat exchanger temperature sensor (middle) error
2d	Heat sink thermistor (P.F.C) error
20	Indoor manual auto switch abnormal
2A	Power supply frequency detection error
17	IPM protection
18	CT error
1A	Compressor location error
1b	Outdoor fan error
1F	Connected indoor unit abnormal
1c	Outdoor unit computer communication error
2E	Inverter error
12	Indoor fan abnormal
0F	Discharge temperature error
24	Excessive high pressure protection on cooling
2c	4-way valve abnormal
16	Pressure switch abnormal, Pressure sensor abnormal
2b	Compressor temperature error
2F	Low pressure error
19	Active filter abnormal
25	PFC circuit error
30	Refrigerant circuit address set-up error
31	Master unit, Slave unit set-up error
32	Connected the indoor number set-up error
33	P.F.C. printed circuit board error

If "C0" appears in the unit number display, there is a remote controller error.

Unit number	Error code	Content
C0	1d	Incompatible indoor unit is connected
C0	1c	Indoor unit ↔ remote controller communication error

13. SPECIAL INSTALLATION METHODS

⚠ CAUTION

- When setting DIP switches, do not touch any other parts on the circuit board directly with your bare hands.
- Be sure to turn off the main power.

[Group control system]

A number of indoor units can be operated at the same time using a single remote controller.

(1) Wiring method (indoor unit to remote controller)

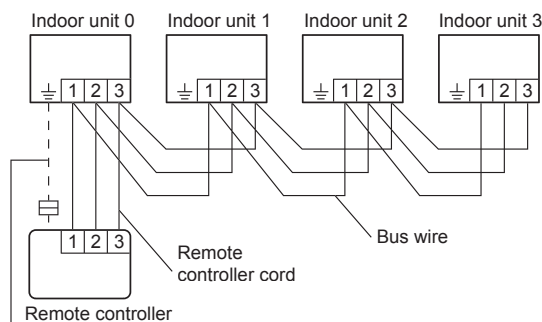

When ground wire is necessary

(2) DIP switch setting (Indoor unit)

Set the unit number of each indoor unit using the DIP switches on the indoor unit circuit board. (See the following table and figure.)

The DIP switches are normally set to make the unit number 0.

Indoor unit

Unit number	DIP SWITCH No.			
	1	2	3	4
0	OFF	OFF	OFF	OFF
1	ON	OFF	OFF	OFF
2	OFF	ON	OFF	OFF
3	ON	ON	OFF	OFF
4	OFF	OFF	ON	OFF
5	ON	OFF	ON	OFF
6	OFF	ON	ON	OFF
7	ON	ON	ON	OFF
8	OFF	OFF	OFF	ON
9	ON	OFF	OFF	ON
10	OFF	ON	OFF	ON
11	ON	ON	OFF	ON
12	OFF	OFF	ON	ON
13	ON	OFF	ON	ON
14	OFF	ON	ON	ON
15	ON	ON	ON	ON

Example : No. 3

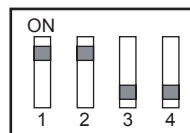

NOTE

Be sure to set the unit numbers sequentially.

(3) Remote controller setting

- Turn on all of the indoor units.
 - *1 Turn on the indoor unit with the unit number 0 last. (Within 1 minute)
 - *2 When the indoor units are turned on, error codes 01 and 31 will be displayed; however, these error codes will be deleted by setting the remote controller. Therefore, continue with the setting procedure.
- Set the refrigerant circuit address. (Assign the same number to all of the indoor units connected to an outdoor unit.)

Refrigerant circuit address	Function Number	Setting Value
	02	00~15

- Set the "master" and "slave" settings. (Set the indoor unit that is connected to the outdoor unit using a transmission cable as the "master".)

	Function Number	Setting Value
Master	51	00
Slave		01

- After completing the function settings, turn off all of the indoor units, and then turn them back on.
 - * If error code 01, 1F, 30, 31, or 32 is displayed, there may be an incorrect setting. Perform the remote controller setting again.

NOTE

When different indoor unit models are connected using the group control system, some functions may no longer be available.

If the group control system contains multiple units that are operated simultaneously, connect and set the units as shown below.

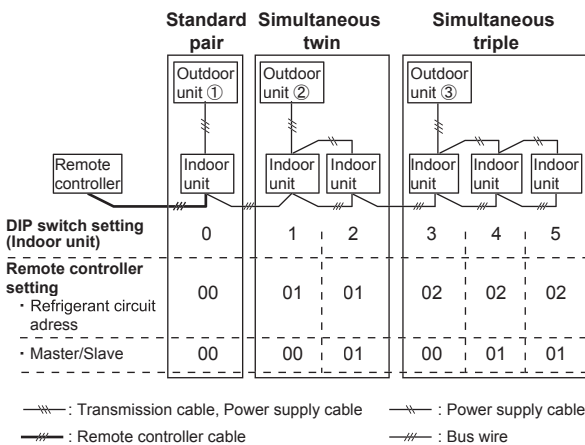

*Make sure that the indoor unit with the unit number 0 is connected to the outdoor unit using a transmission cable.

14. FRESH-AIR INTAKE

- Open up the knockout hole for the fresh-air intake, as shown in the figure. (If using half-concealed installation, open up the top knockout hole instead.)

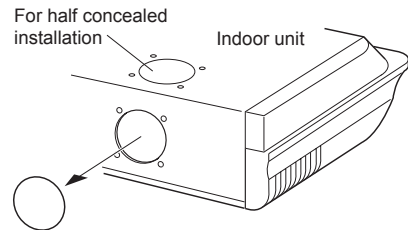

CAUTION

- When removing the cabinet (iron plate), be careful not to damage the indoor unit internal parts and surrounding area (outer case).
- When processing the cabinet (iron plate), be careful not to injure yourself with burrs, etc.

- Fasten the round flange (optional) to the fresh-air intake, as shown in the figure. (If using half-concealed installation, attach to the top.)

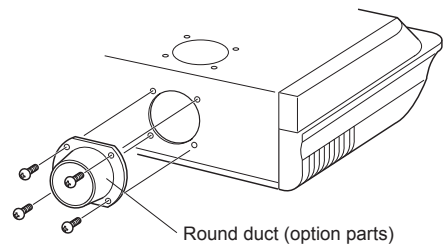

[After completing "3. INSTALLATION WORK"...]

- Connect the duct to the round flange.
- Seal with a band and vinyl tape, etc. so that air does not leak from the connection.

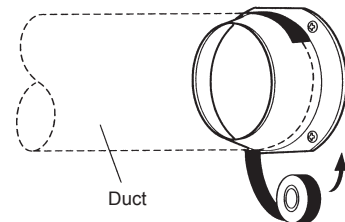

15. CUSTOMER GUIDANCE

Explain the following to the customer in accordance with the operating manual:

- Starting and stopping method, operation switching, temperature adjustment, timer, air flow switching, and other remote control unit operations.
- Air filter removal and cleaning, and how to use the air louvers.
- Give the operating and Installation Manuals to the customer.
- If the signal code is changed, explain to the customer how it changed (the system returns to signal code A when the batteries in the remote control unit are replaced).
 - * (4) is applicable to using wireless remote control.